

SEIKO watch technical information



① REPAIRING AND CHECKING
METHODS OF
CAL, 7005A AND 7006A

② REPAIRING AND CHECKING
METHODS OF
CAL, 6138A AND 6139A

SEIKO

K. HATTORI & CO., LTD. TOKYO, JAPAN

REPAIRING AND CHECKING METHODS OF CAL, 7005A AND 7006A

When malfunctions exist in the automatic winding mechanism, phenomena can be roughly divided into the following two conditions:

1. Manually shaking the watch, rattling or scratching sounds are generated.
2. Manually shaking the watch, no sound is heard.

A. When rattling or scratching sounds are generated.

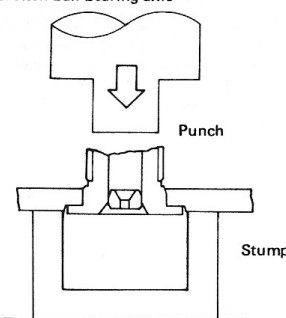
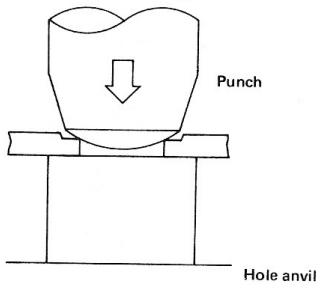
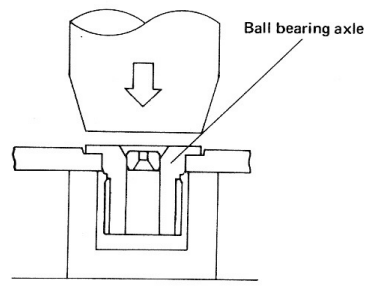
Item	Cause of malfunction	Repairing method
1	Broken ball bearing axle	<p>Replace the ball bearing axle with a new one. Instruments for repairing: Staking tool Part No. 828002</p> <p>1) Pull out the broken ball bearing axle</p>  <p>2) Squeeze the hole for the ball bearing axle of the barrel and train wheel bridge by using the staking tool</p>  <p>3) Drive in a new ball bearing axle</p> 

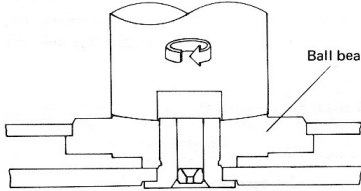
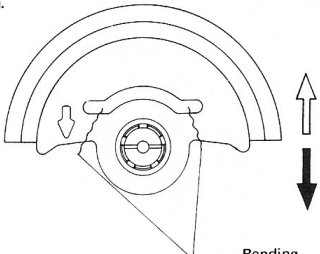
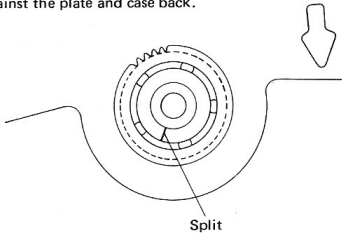
Item	Cause of malfunction	Repairing method
2	<p>Oscillating weight is detached from the ball bearing</p>	<p>Replace the oscillating weight.</p> <p>When tightening the screw for oscillating weight fork, use a special driver as below. Clamping force should be three or four times that of the bridge screw for man's wrist watch.</p> 
3	<p>Warp of the oscillating weight.</p> <p>As the oscillating weight is warped, it strikes against the plate, first reduction wheel, or case back.</p> <p>Oscillating weight is too high . . . →</p> <p>Oscillating weight is too low . . . →</p> <p>Note: Take care so that the pushing strength of the ball bearing or the oscillating weight is not too heavy.</p>	<p>Correcting or replacing of the oscillating weight.</p> <p>Adjust it by manually pressing the surrounding portion of the ball bearing.</p> 
4	<p>Holding ring for ball bearing is split.</p> <p>As the ball bearing is shaken, oscillating weight strikes against the plate and case back.</p> 	<p>Replacing of the oscillating weight</p> <p>Part No. Cal. 7001, 7005, 7006 509004 Cal. 7017 509007</p>

B. When shaking the watch, no sounds are generated.

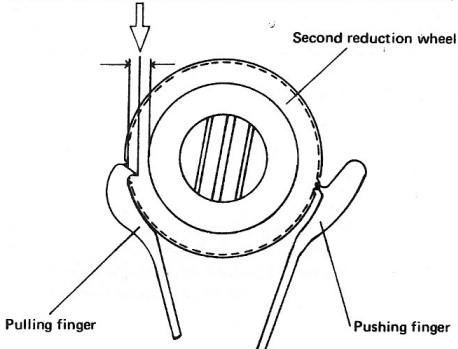
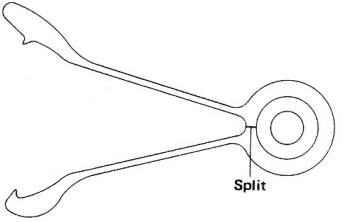
Item	Cause of malfunction	Repairing method
1	<p>Pawl lever is excessively opened.</p> <p>The second reduction wheel is not rotated because the tips of the pawl lever are opened too much.</p>	<p>Correct the pawl lever</p> <p>Correct the lever so that the pulling finger tip comes halfway between the tooth bottom and the inner diameter of the wheel.</p> 
2	<p>Split of the pawl lever</p> <p>The second reduction wheel is not rotated because the tip of the pawl lever is opened by it's splitting too much.</p> 	<p>Replace the pawl lever</p> <p>Part No. Cal. 7001, 7005, 7006, 7019831001 Cal. 7017831002</p>

REPAIRING AND CHECKING METHODS OF CAL. 6138A AND 6139A

In spite of being a multi-functional watch classified as an "automatic winding chronograph," 6138A and 6139A are designed to facilitate repairs through SEIKO's extremely simplified and unique construction. However, compared with ordinary watches, since inspection and adjustment of the chronograph mechanism are added, increased difficulties arise in making repairs to these watches.

Checking and repairing methods of 6138A and 6139A described herein have been assembled from customers' letters on problems and selected from among them, a wealth of information contributed to SEIKO (but excluding general repair methods) to facilitate simple and smooth repairing as much as possible.

- (ITEMS)
1. The second hand does not return to the 0 position even when depressing the fly-back button.
 2. Fly-back operation cannot be performed.
 3. Starting and stopping operations cannot be performed.
 4. Actually measured value of the second hand is abnormally advanced.
 5. Stopping.

1. The second hand does not return to the 0 position even when depressing the fly-back button.

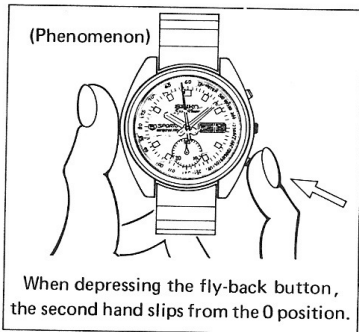

- **Checking of the second hand**
 - 1 Is the second hand bent?
 - 2 Is the tube for sweep second hand cracked?
 - 3 Is there any loosened portion on the caulked point of the tube for sweep second hand?
 - 4 Does looseness exist between the tube and the axle?
- **Checking of the center chronograph wheel**
 - 5 Does looseness exist between the center chronograph wheel axle and the bush?

Checking procedures and repairing methods.

Item	Checking points	Repairing method
1	<p>Checking of the bent of the second hand</p> 	<p>When a bend is slight, correct it. When a bend is serious, replace the second hand.</p>

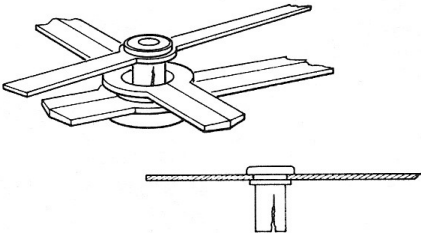
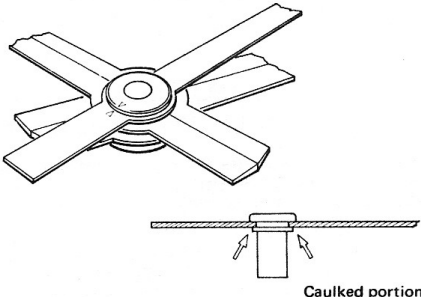
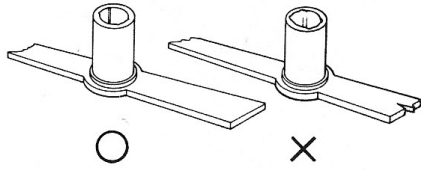
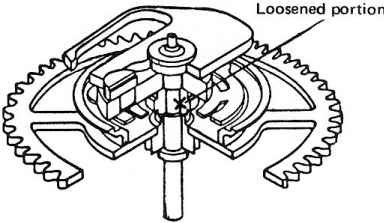
Item	Checking points	Repairing method
2	<p>Checking of the tube after removing the case</p> 	<p>Replace the second hand.</p>
3	<p>Checking of the slip by putting a mark on the tube head and the second hand respectively</p>  <p>Caulked portion</p>	<p>Replace the second hand.</p>
4	<p>Checking of the strength while pulling out the second hand and also checking the shape after pulling out the second hand.</p> <p>The shape after pulling out the hand is as shown in the diagram on the left and pulling strength is large.(○)</p> <p>Shape after pulling out the hand is as shown on the right and pulling strength is small.(×)</p> 	<p>Replace the second hand.</p>
5	 <p>Loosened portion</p>	<p>Replace the center chronograph wheel.</p>

2. Fly-back operation cannot be performed

(Phenomenon)
 Button cannot be depressed and
 fly-back operation is not performed.



1) When the button cannot be depressed
 Is the hammer click too strong or is it worn?

	Checking points	Repairing method
<p>1</p>	<p>1. As shown in the lower diagram, when depressing the button after detaching the hammer click upward, if the hammer operates, the hammer click is too strong. (Lack of oil and abrasion are considered)</p>	<p>As shown in the lower diagram, weaken the hammer click by bending it in the arrow direction. After correcting hammer click, lubricate the contacting portion with S-4 oil.</p>

(Phenomenon)
 Button can be depressed, but the
 second hand does not return to the 0
 position.

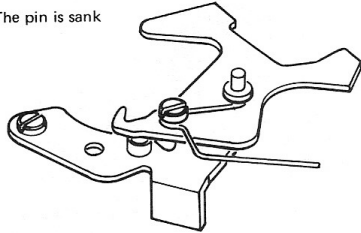
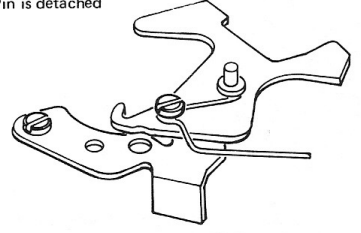
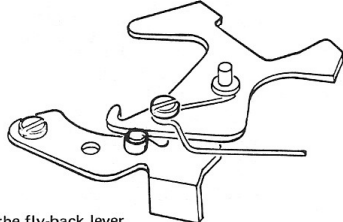
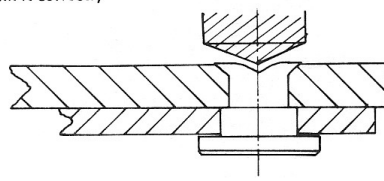
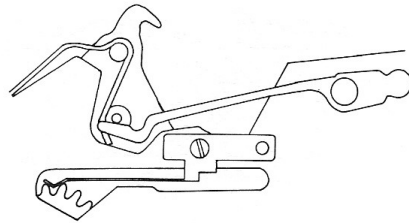
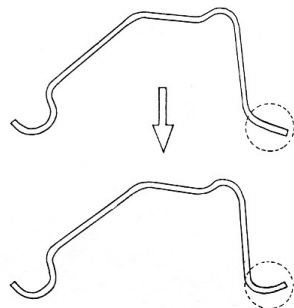

2) When the button can be depressed
 Has the fly-back lever pin slipped completely in or is it detached?
 Does the hammer return?

	Checking points	Repairing method
<p>2</p>	<p>2. Checking of sunken or detached fly-back lever pin.</p> <p>The pin is sank</p>  <p>Pin is detached</p> 	<p>Pull out sunken pin.</p> <p>When the hammer is bent, flatten it correctly.</p>  <p>Replace the fly-back lever</p> <p>Caulk it correctly</p> 
<p>3</p>	<p>3: Check whether or not the hammer spring is on the bridge.</p> <p>As the spring is obstructed by the bridge it does not work.</p> 	<p>Correct the spring tip as shown in the lower diagram.</p> 

3. Starting and stopping operations cannot be performed

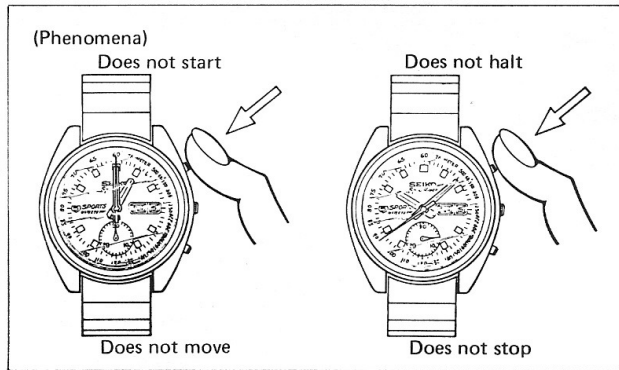

- 1) When the button cannot be depressed
The pillar wheel cannot be forwarded due to stopped hammer.
- 2) When the button can be depressed, but the second hand does not start or stop.
Is there shortage of a stroke of the operating lever?
Has the operating lever axle dropped off?

Item	Checking points	Repairing method
1	<p>Checking whether or not the fly-back lever pin is sank.</p> <p>Sunken pin</p>	<p>Correct sunken condition of the pin.</p> <p>When lever is bent, flatten it correctly.</p>
2	<p>Checking shortage of stroke caused by adhering silicon grease between button and operating lever.</p> <p>Stroke shortage</p> <p>Checking shortage of stroke due to detached operating lever spring from the axle.</p>	<p>Wipe off silicon grease adhered to button and lever.</p> <p>Correct the spring shape to stop its detaching from the axle (shown in lower diagram)</p>
3	<p>Detached axle</p>	<p>Recaulk the operating lever.</p>

4. Actually measured value of the second hand is abnormally advanced

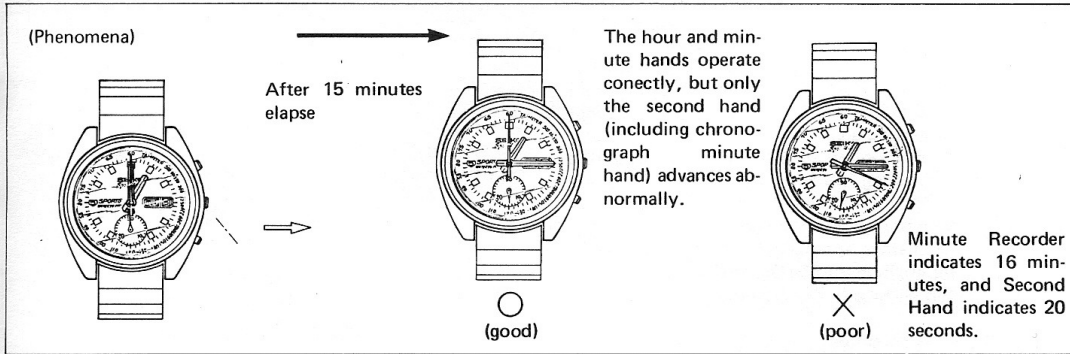

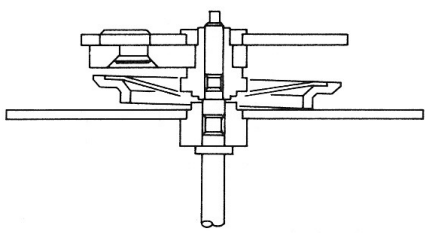
Item	Checking points	Repairing method
1	<p>Weakened clutch spring for center chronograph.</p> 	<p>Replace the center chronograph wheel.</p>

(Reference: Checking method of clutch slip on the movement)

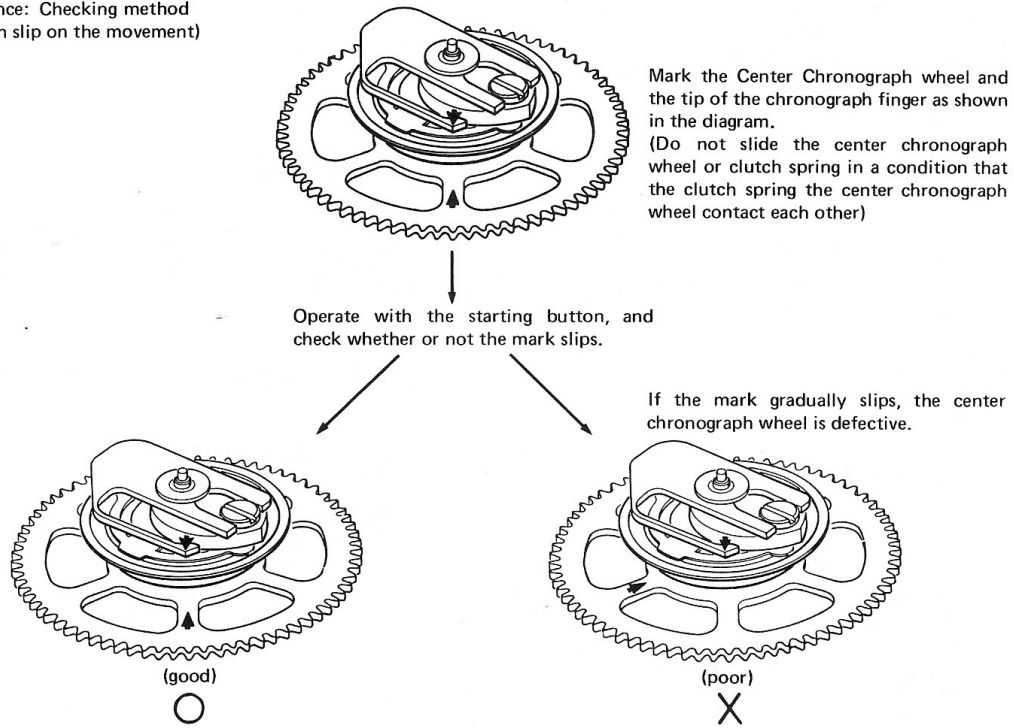

5. Stopping



(Phenomenon)

Stopping . . . Balance halts when the mainspring is wound more than one winding.

Note: When the balance continuously moves but the second hand does not move, refer to Item 3: Starting and Stopping Operation Cannot be Performed.

As mechanisms of 6139 and 6138, when the mainspring becomes loosened, the second hand stops around 58 seconds (even in an accurate watch). Consequently, if the second hand stops at around 58 seconds, this cannot be attributed to STOPPING as mentioned in this paragraph. Pay attention to this point.

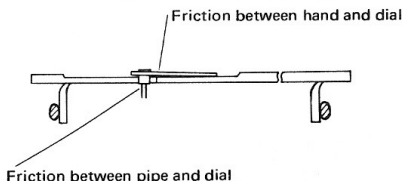
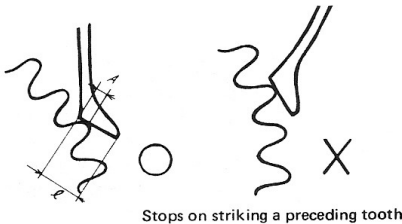
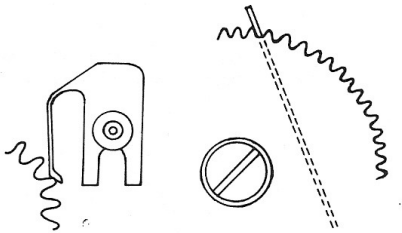
1) Halts at starting condition

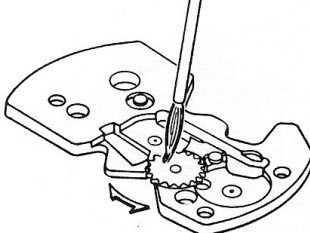
Item	Checking points	Repairing method
1	<p>Does rubbing occur between the chronograph minute hand and the dial?</p> 	<p>Correct the horizontal slip of dial and the clearance between dial and hands.</p>
2	<p>Is the chronograph finger bent?</p>  <p>Stops on striking a preceding tooth</p>	<p>Correct a bent finger.</p> <p>Biting amount: A: 1/2 – 1/4ℓ</p>
3	<p>Is chronograph finger resistance strong?</p> <p>1) Minute recording jumper spring tension is too strong.</p> <p>2) Stain of oil adhered to the intermediate minute recording wheel.</p> <p>(Checking method)</p> <p>After removing the automatic winding section, balance and pallet, release the mainspring in a starting condition.</p>  <p>As shown in the above diagram, when the ratchet wheel is slowly wound in minute forwarding condition, if the train wheel rotates within 9 ratchet wheel teeth, minute recording is in good condition.</p>	<p>1) Adjust strength of minute recording jumper</p> <p>Do not adjust strength too weakly</p>  <p>2) Clean the chronograph bridge to facilitate revolution of the intermediate minute recording wheel.</p>  <p>Use a soft brush to check the revolving condition.</p>

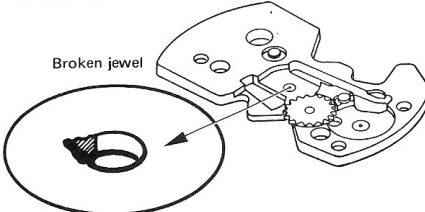
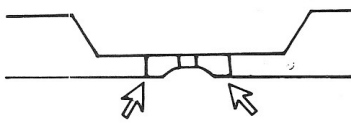
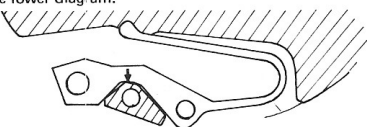
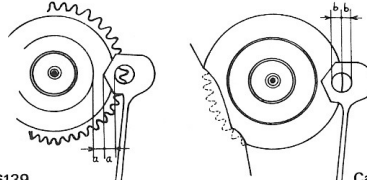
Item	Checking points	Repairing method
4	<p>Is the hole jewel of the chronograph bridge cracked?</p>  <p>Broken jewel</p>	<p>Replace the hole jewel.</p>  <p>Caulk it from the front side.</p>
5	<p>Is calendar forwarding torque too strong?</p> <p>Easy to stop when calendar forwarding and minute forwarding are doubled.</p>	<p>Weaken the day and date jumper with the limitation indicated in the lower diagram.</p>  <p>Adjust the strength by bending the lever so that the half of the round point of the lever is put on the oblique line portion.</p>  <p>Cal. 6139</p> <p>Cal. 6138</p>

2) Halts at stopping condition

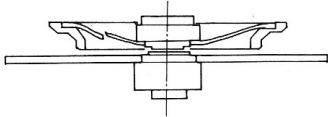
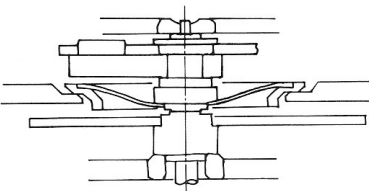
Item	Checking points	Repairing method
6	<p>Does the clutch operate normally?</p> <p>1) Damaged clutch spring</p>  <p>2) Clutch does not operate</p> 	<p>Replace the center chronograph wheel.</p> <p>Lower the upper hole jewel position to facilitate clutch operation.</p> <p>(When shakes of the center chronograph wheel disappear, also adjust shakes of the center wheel and pinion)</p>